

72" x 48"

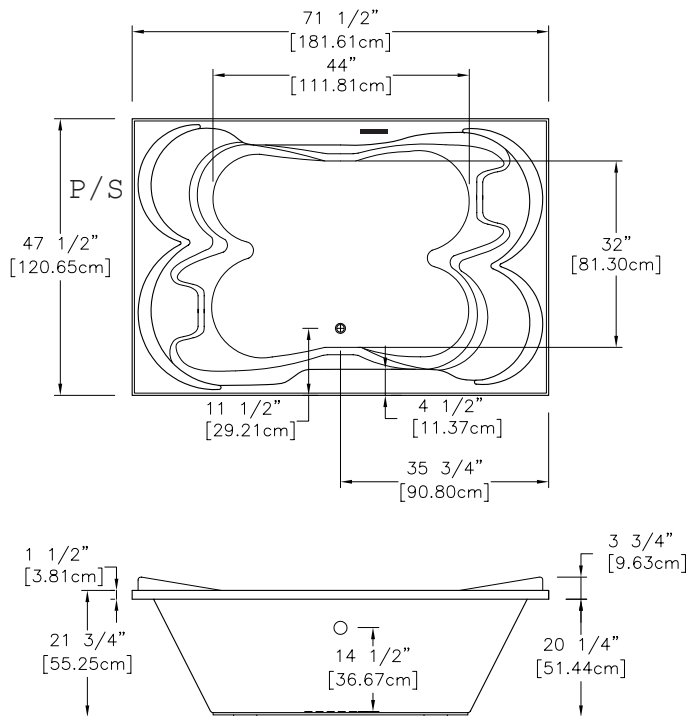

SHERLIC bathtubs come with a superior quality finish that requires protection during shipping and handling. The high gloss surface is shock resistant and will conserve its appearance for years to come if properly cared for and maintained. It is the consignee's responsibility to advise the shipper of any damage incurred in transit. Any missing items must be carefully indicated on the receiving slip.

**DO NOT USE ABRASIVE CLEANSERS, METAL SCRAPERS OR ANYTHING ELSE THAT COULD SCRATCH OR DULL THESE SURFACES.**

#### ADD 2 3/8" FOR AN INJECTAIR BATHTUB

The position of the whirlpool or injectair therapeutic jets do not necessarily represent the actual installation.

- 1- Upon delivery, ensure that the unit has not been damaged.
- 2- Place the unit in the room where it is to be installed before work begins. Disassemble sections as required.
- 3- If your bath/shower is protected with a plastic film, remove it only at the last minute.
- 4- Ensure that the floor is level and strong enough to support the weight of the bathtub when filled with water.
- 5- Whirlpool and Injectair systems must be connected prior to final installation (see whirlpool and Injectair installation guide).
- 6- If your bathtub is equipped with a whirlpool or Injectair system, you must provide for access allowing easy disassembly of the pump and/or blower.
- 7- All electrical connections must be made by a licensed electrician in compliance with local building codes. Never operate the bathtub unless it has been connected to a differential circuit breaker through a 30 minute timer located out of the bather's reach.
- 8- Verify the bathtub upon installation. Fill the tub to maximum capacity, run the system and check for leaks.

#### IF THE BATH IS EQUIPPED WITH A WHIRLPOOL OR INJECTAIR SYSTEM:

Connect only to a circuit protected by ground fault circuit breaker and controlled by an automatic, adjustable time switch with a 30 min. maximum time, all controls shall be located out of reach of a person in the tub.

The measurements found in this document are approximate. SHERLIC Inc. is not responsible for installations made with the measurements indicated in this booklet or any other promotional document.